



PL/LL PUMPS

SECTION

PAGE

PL/LL

1

PL PERFORMANCE FIELDS

SUPERSEDES

ISSUED

1/97

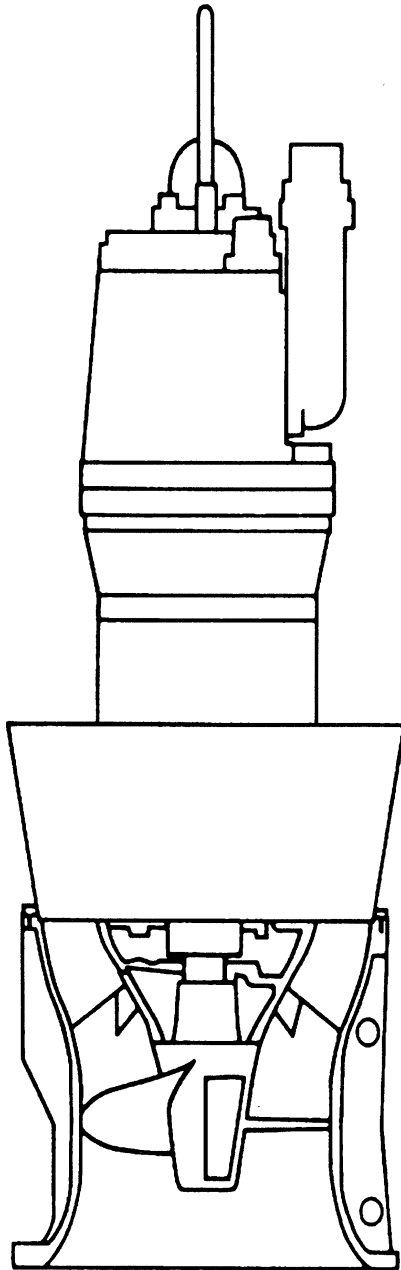

Use for pre-selection only.

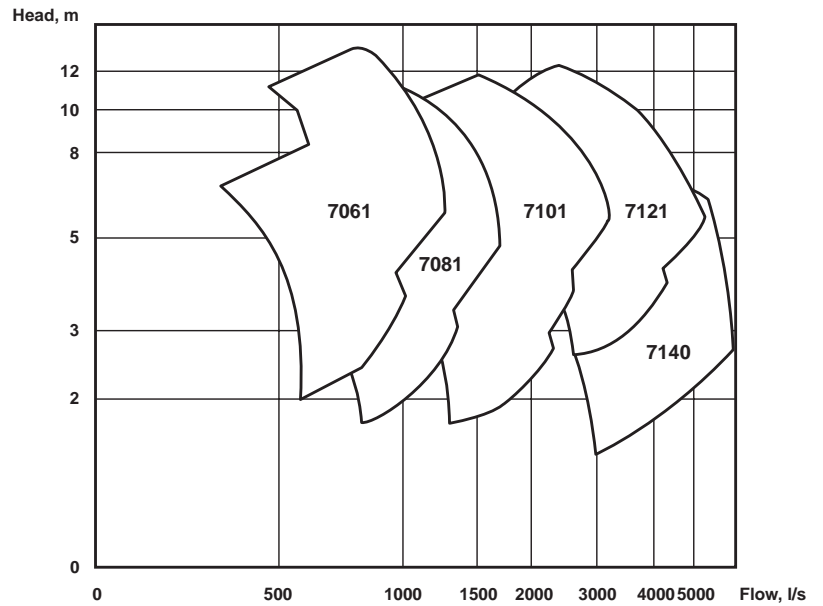
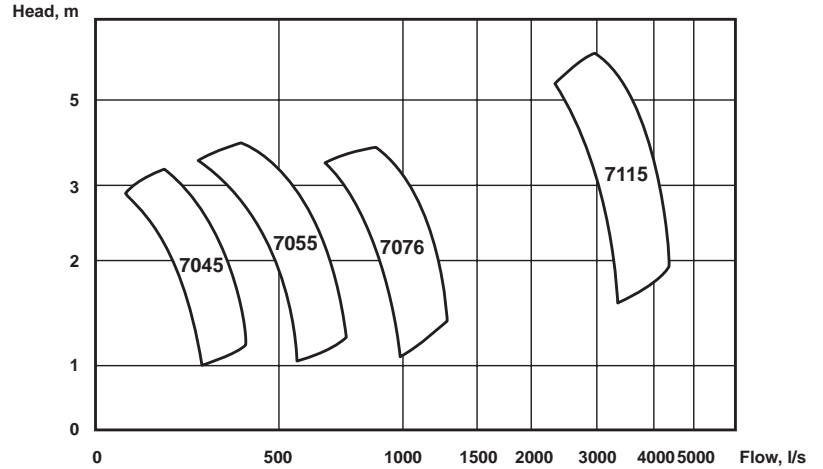

ITT Flygt Series P-7000 Electric Submersible Propeller Pumps have a well known and uncontested ability to handle lowhead high capacity pumping. Applications range from agricultural uses, such as irrigation and land drainage, to flood control and the pumping of municipal

storm water effluent. Other applications include pumping of water from waste water treatment plants, water used in industrial processes, cooling applications, raw water and water rides in amusement parks.

ITT Flygt

An ITT Industries company

Models

7045/7050 13-63 kW (17-84 HP)	7055/7061 15-179 kW (20-240 HP)	7076/7081 18-186 kW (34-250 HP)	7101 67-265 kW (90-355 HP)	7115/7121 138-399 kW (185-535 HP)
--	--	--	---	--

Models	Discharge Tube Dia. (mm)
--------	-----------------------------

PL-7045	700	Heights:
PL-7050	700	56.5" to 158"
PL-7055	800	
PL-7061	800	Widths:
PL-7076	1000	24.4" to 61"
PL-7081	1000	
PL-71 01	1200	
PL-7115	1400	Weights:
PL-7121	1400	1,200 lbs. to 20,500 lbs.

Installation

The integral pump/drive unit is installed in a discharge column. This means that the pump/drive unit may be lowered inside the discharge column down to its seat at the base of the discharge column. The pump is held in place by its own weight. With proper hoisting equipment, it is easy to remove the unit from the column for inspection or service.

Propeller Pump Section

The pump section includes a propeller and a guide vane system. The latter also forms the bowl assembly, which holds the pump section and driving unit together. The bowl assembly is designed to match the inside diameter of the discharge column with an adequate clearance to raise and lower the entire pump/motor unit. A seat is provided at the bottom of the discharge column to support the weight of the pump/motor unit.

The bowl assembly is provided with a replaceable wear ring at the propeller periphery.

Materials

The outer casing of the driving unit is made of cast iron. The guide vane system (bowl assembly) is made of cast iron.

The propeller is available in either cast iron, aluminium bronze or stainless steel depending on pump model and application.

Practical Limitations

The 7000 series can pump liquids at temperatures of up to 40°C (104°F).

Maximum pump submergence is 20 m.

Five Low-Cost Types of Installations

In order to reduce installation costs, ITT Flygt has standardized the main elements of pumping stations so that they can be combined in different ways to match specific site

conditions. The five examples shown here, illustrating the flexibility of the system, provide guidelines for optimizing the design of your station.

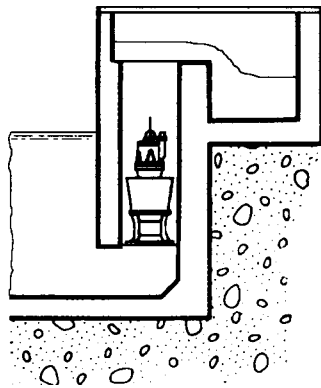

Suitable where the liquid is pumped to a tunnel, channel or basin with a water level that is nearly constant so that shutoff devices are not required.

This arrangement involves the smallest number of steel components; it consists of a circular concrete shaft and a short pipe grouted in place as a base for the pump.

Water cannot run back to the sump when the pump is shut off because the top of the shaft is placed at a level slightly above the maximum water level in the channel.

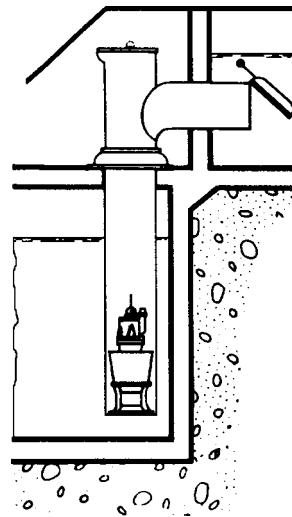

If the water level on the outlet side of the pump varies considerably, flap valves can be installed. Normally the pump works against the head in the discharge channel or basin; when the pump is not in operation, the water is prevented from running back to the sump by the automatic closure of the valve. In this way, the pump always operates against the minimum head. The discharge elbow is used because of its low losses and comparatively simple construction.

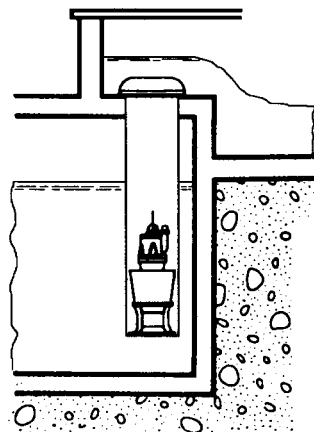

In this case the pump is placed in a steel column with a collar that rests on a supporting frame. Steel work is marginally more expensive, but civil construction costs are somewhat lower.

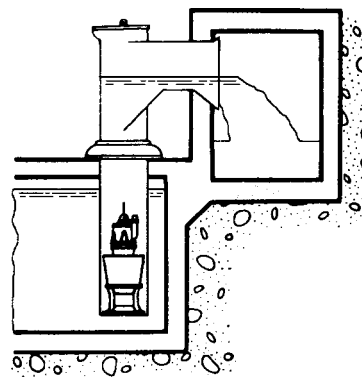

If odours require a closed system, this arrangement can be used with either a free discharge, as shown, or with a flap valve. In either case, a cover can be so placed as to prevent any overflow.

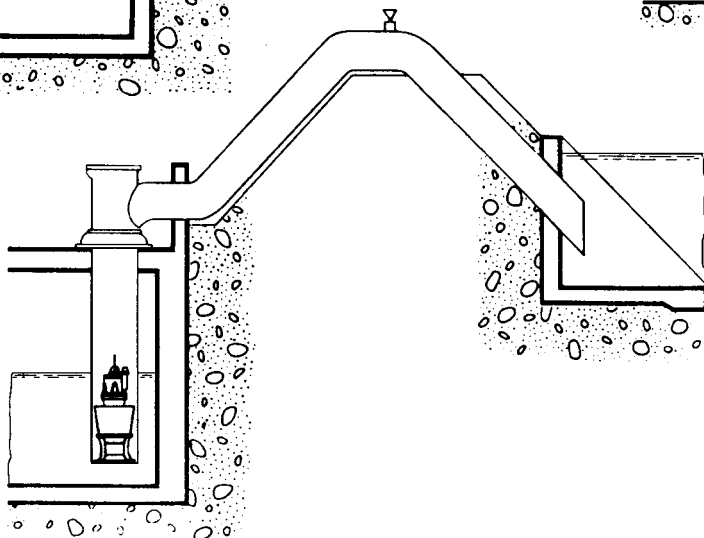

If the pump is to work in combination with a siphon or a discharge line, a pressure-tight discharge elbow must be used. The elbow recommended here permits both fast installation and easy retrieval of the pumps.

LL PERFORMANCE FIELDS

Use for pre-selection only.

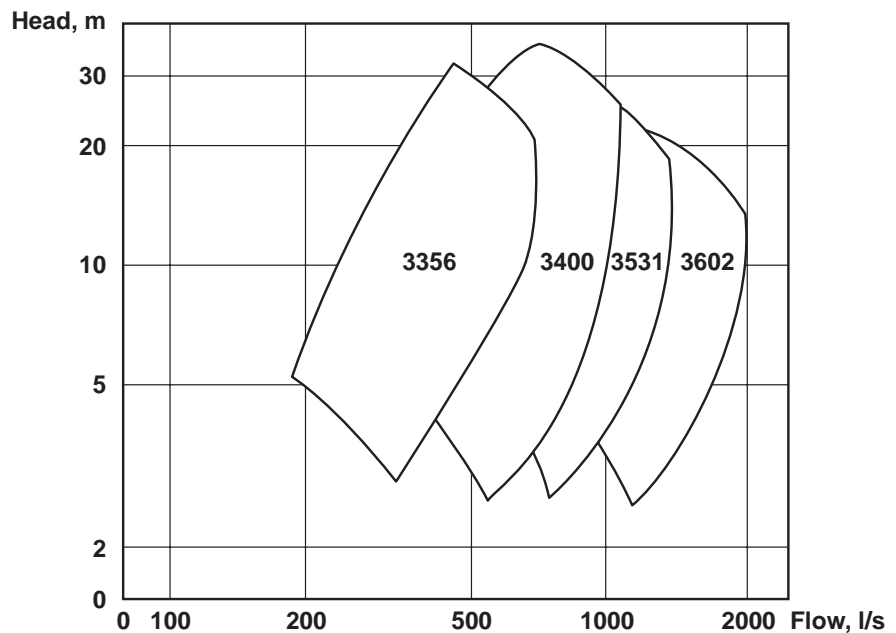
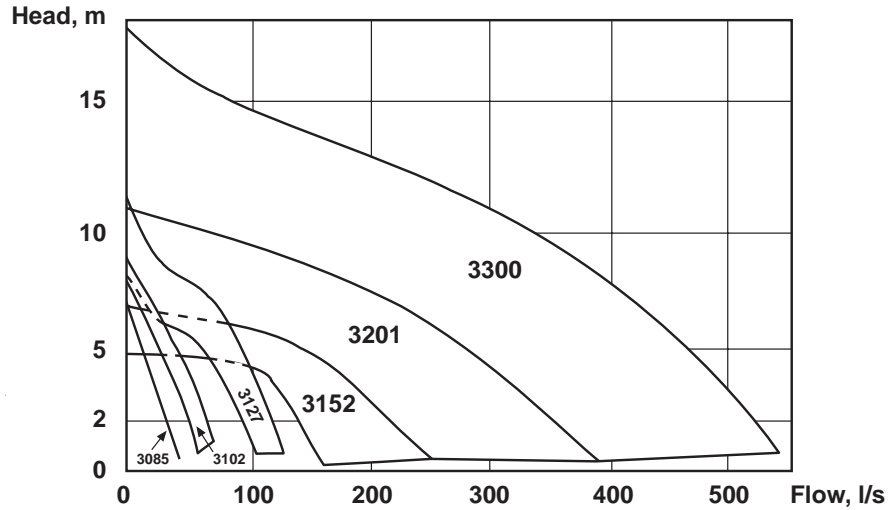
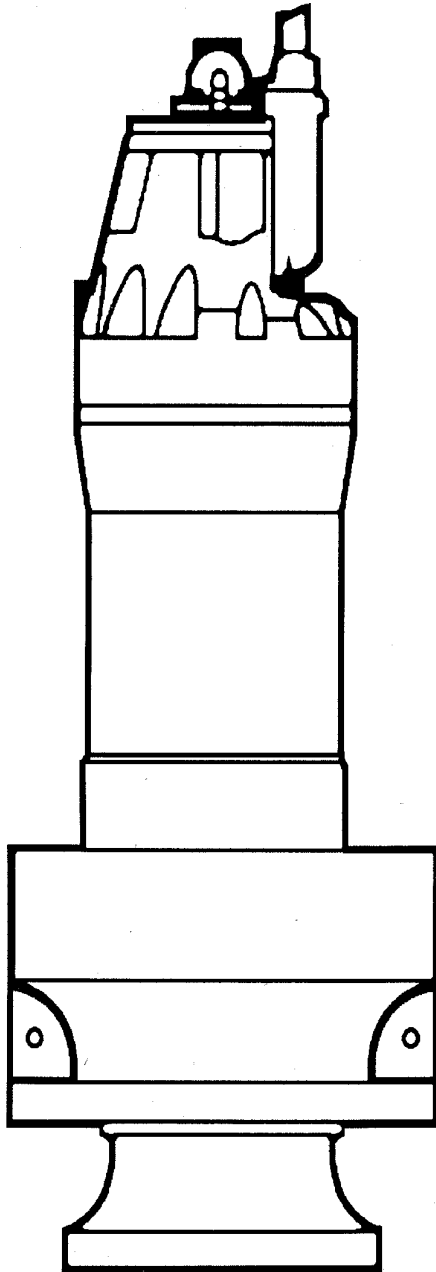

The LL-3000 series Vertical Mixed Flow Pumps were developed for the pumping of small to large volumes of raw water for use in marine pumping applications, secondary and final treatment plant effluent, storm water,

amusement park water rides and any application where low to medium head pumping of clean, raw or partially contaminated water is required.



PL/LL PUMPS

SECTION

PAGE

PL/LL

5

LL CHARACTERISTICS

SUPERSEDES

ISSUED

1/97

12/99

The basic design of the LL-3000 series pump is a combination of the standard line of ITT Flygt heavy duty electric submersible motor units coupled with solids handling, mixed-flow impellers which utilize a diffuser having three or more guide vanes to stabilize the discharge flow. This diffuser is used in lieu of a centrifugal pump volute.

The LL-3000 series mixed-flow pump is installed simply lowering the one piece motor/pump unit into its discharge column pipe and onto the pump mounting plate. The weight of the motor/pump unit firmly seats the pump to its mounting plate.

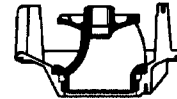

NON-CLOG MIXED FLOW IMPELLER

LL

PERMANENT INSTALLATION IN A VERTICAL DISCHARGE COLUMN

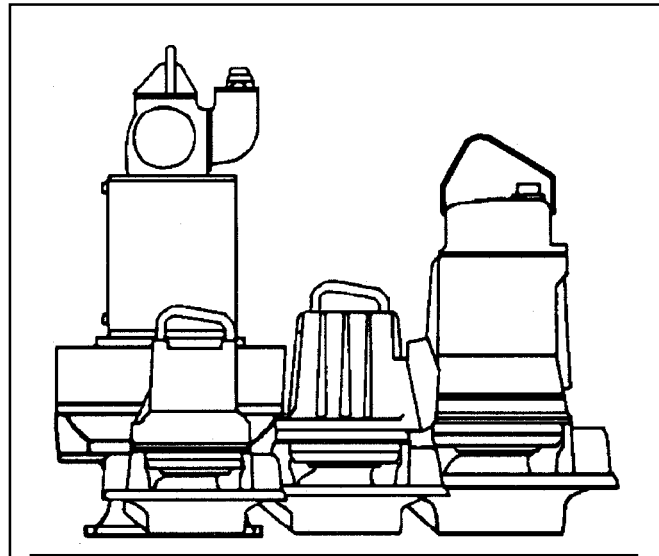

Model	Horsepower
LL-3085	3.2
LL-3102	5
LL-3127	7.4 - 10
LL-3152	14
LL-3201	30
LL-3300	45 - 60
LL-3356	27 - 310
LL-3400	35 - 350
LL-3531	70 - 600
LL-3602	90 - 565

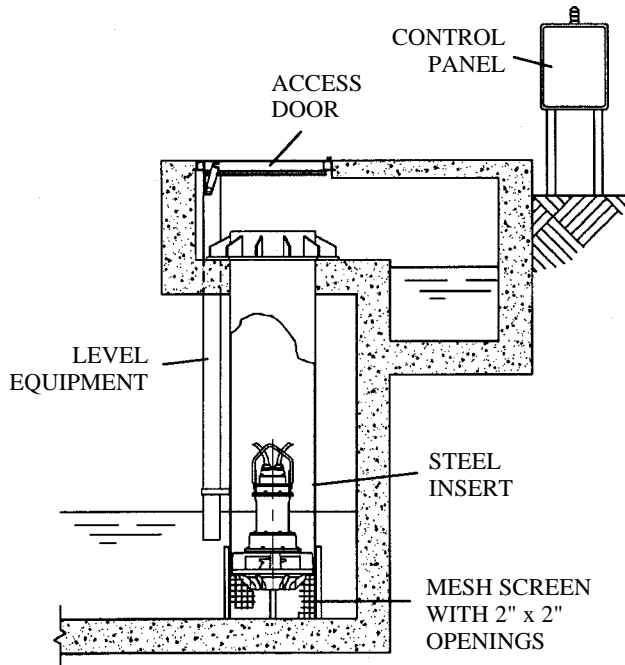

Steel Tube Installation

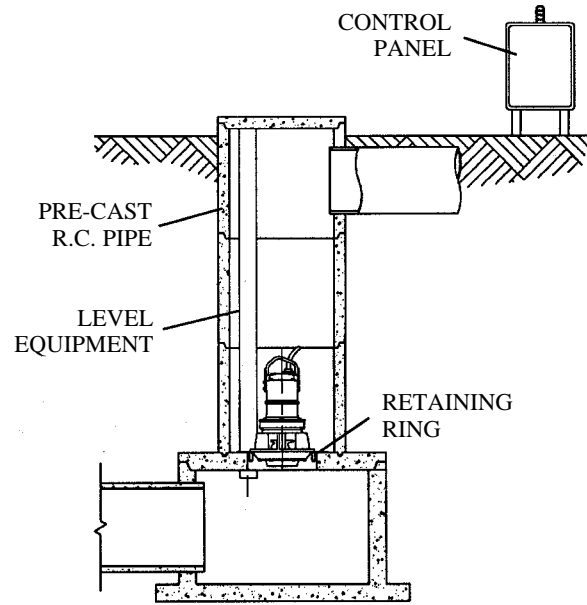

Concrete Installation

Contact your nearest ITT Flygt representative for additional information.